

RF & MICROWAVE TRANSISTORS L-BAND RADAR APPLICATIONS

- REFRACTORY/GOLD METALLIZATION
- EMITTER SITE BALLASTED
- RUGGEDIZED VSWR $\infty:1$
- LOW THERMAL RESISTANCE
- INPUT/OUTPUT MATCHING
- OVERLAY GEOMETRY
- METAL/CERAMIC HERMETIC PACKAGE
- $P_{OUT} = 26$ W MIN. WITH 7.2 dB GAIN

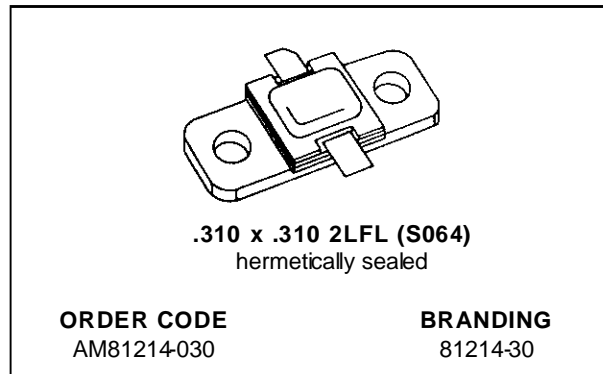

DESCRIPTION

The AM81214-030 device is a high power transistor specifically designed for L-Band Radar pulsed driver applications.

The device is capable of operation over a wide range of pulse widths, duty cycles and temperatures and is capable of withstanding $\infty:1$ output VSWR at rated RF conditions. Low RF thermal resistance and computerized automatic wire bonding techniques ensure high reliability and product consistency.

The AM81214-030 is supplied in the IMPAC™ Hermetic Metal/Ceramic package with internal Input/Output matching structures.

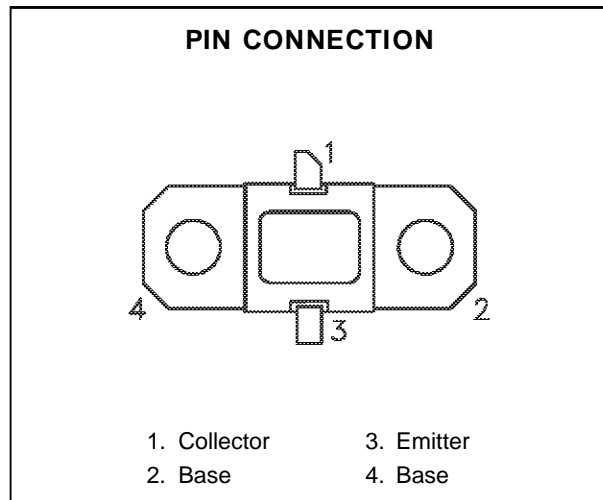

ABSOLUTE MAXIMUM RATINGS ($T_{case} = 25^{\circ}C$)

Symbol	Parameter	Value	Unit
P_{DISS}	Power Dissipation* ($T_C \leq 100^{\circ}C$)	63	W
I_C	Device Current*	2.75	A
V_{CC}	Collector-Supply Voltage*	32	V
T_J	Junction Temperature (Pulsed RF Operation)	250	$^{\circ}C$
T_{STG}	Storage Temperature	- 65 to +200	$^{\circ}C$

THERMAL DATA

$R_{TH(j-c)}$	Junction-Case Thermal Resistance*	2.4	$^{\circ}C/W$
---------------	-----------------------------------	-----	---------------

*Applies only to rated RF amplifier operation

AM81214-030

ELECTRICAL SPECIFICATIONS ($T_{\text{case}} = 25^{\circ}\text{C}$)

STATIC

Symbol	Test Conditions		Value			Unit
			Min.	Typ.	Max.	
BV_{CBO}	$I_{\text{C}} = 10\text{mA}$	$I_{\text{E}} = 0\text{mA}$	55	—	—	V
BV_{EBO}	$I_{\text{E}} = 1\text{mA}$	$I_{\text{C}} = 0\text{mA}$	3.5	—	—	V
BV_{CER}	$I_{\text{C}} = 20\text{mA}$	$R_{\text{BE}} = 10\Omega$	55	—	—	V
I_{CES}	$V_{\text{BE}} = 0\text{V}$	$V_{\text{CE}} = 28\text{V}$	—	—	5	mA
h_{FE}	$V_{\text{CE}} = 5\text{V}$	$I_{\text{C}} = 1\text{A}$	15	—	150	—

DYNAMIC

Symbol	Test Conditions			Value			Unit
				Min.	Typ.	Max.	
P_{IN}	$f = 1215 - 1400\text{MHz}$	$P_{\text{IN}} = 5\text{W Peak}$	$V_{\text{CC}} = 28\text{V}$	26	36	—	W
η_{C}	$f = 1215 - 1400\text{MHz}$	$P_{\text{IN}} = 5\text{W Peak}$	$V_{\text{CC}} = 28\text{V}$	45	49	—	%
G_{P}	$f = 1215 - 1400\text{MHz}$	$P_{\text{IN}} = 5\text{W Peak}$	$V_{\text{CC}} = 28\text{V}$	7.2	8.5	—	dB

Note: Pulse Width = $1000\mu\text{S}$
Duty Cycle = 10%

TYPICAL PERFORMANCE

RELATIVE POWER OUTPUT & COLLECTOR EFFICIENCY vs COLLECTOR VOLTAGE

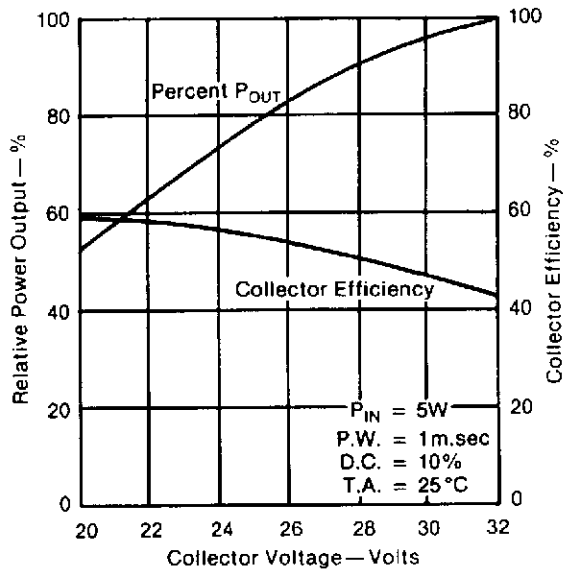

TYPICAL BROADBAND POWER AMPLIFIER

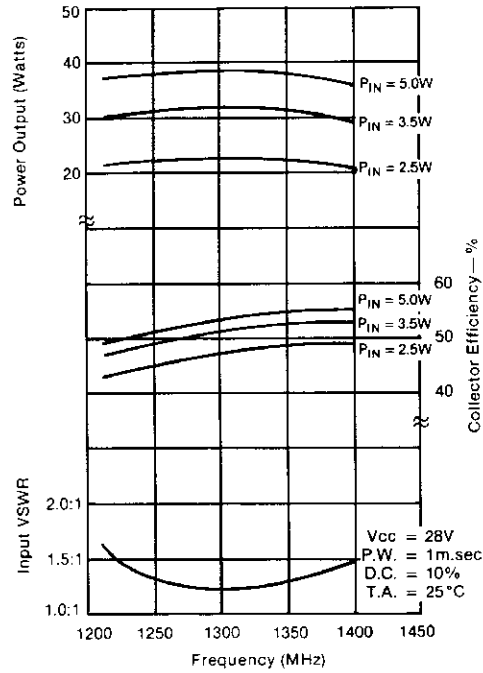

MAXIMUM THERMAL RESISTANCE vs PULSE WIDTH

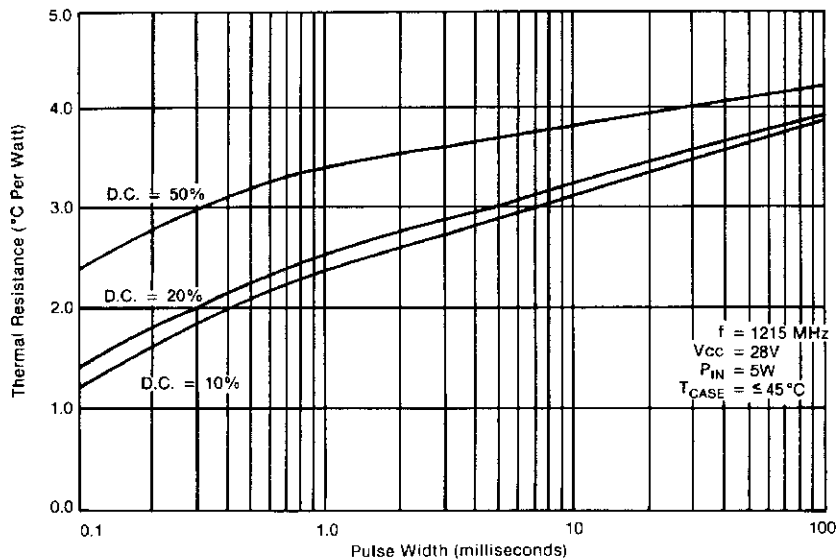

IMPEDANCE DATA

TYPICAL INPUT IMPEDANCE

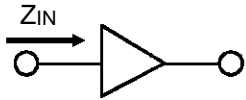

$P_{IN} = 5.0\text{ W}$
 $V_{CC} = 28\text{ V}$
 $Z_0 = 50\text{ Ohms}$

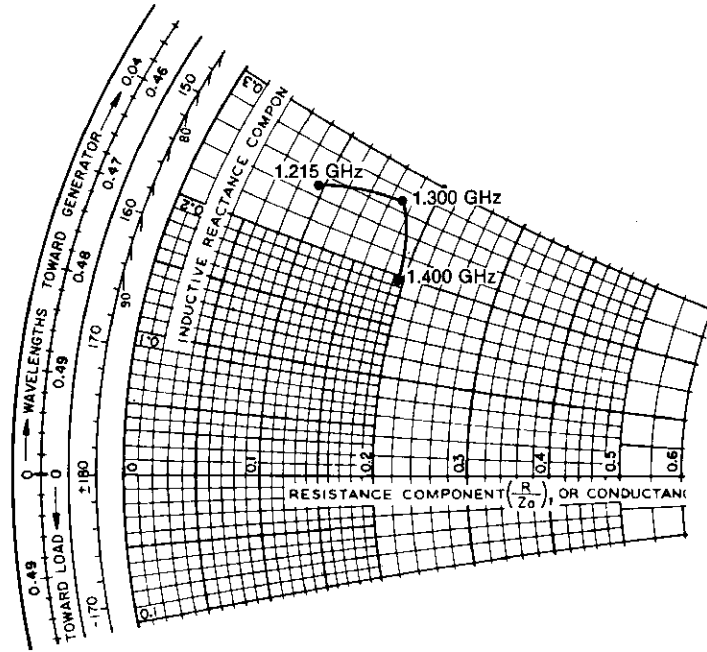

FREQ.	$Z_{IN} (\Omega)$	$Z_{CL} (\Omega)$
L = 1.215 GHz	$4.5 + j 12.5$	$11.0 - j 10.0$
M = 1.300 GHz	$8.5 + j 13.5$	$10.5 - j 6.5$
H = 1.400 GHz	$9.5 + j 10.0$	$8.0 - j 5.0$

TYPICAL COLLECTOR LOAD IMPEDANCE

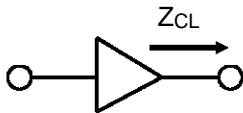

$P_{IN} = 5.0\text{ W}$
 $V_{CC} = 28\text{ V}$
 $Z_0 = 50\text{ Ohms}$

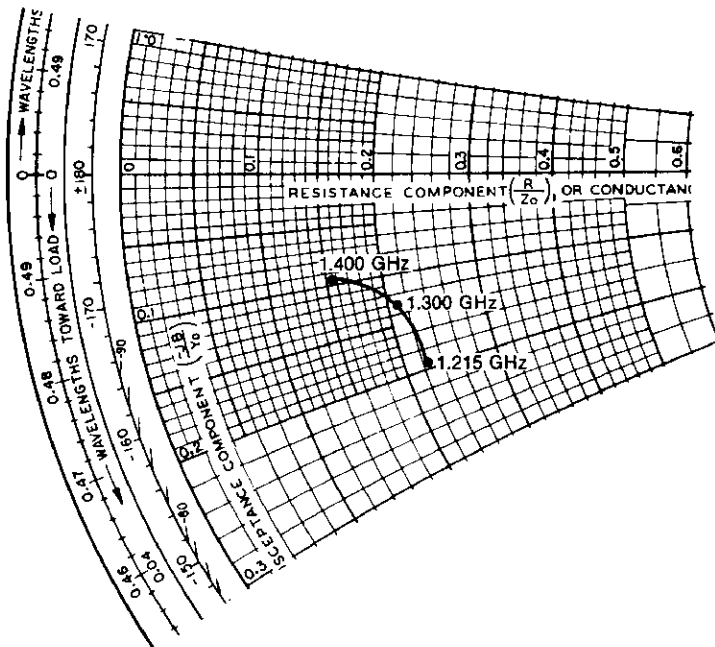

Information furnished is believed to be accurate and reliable. However, SGS-THOMSON Microelectronics assumes no responsibility for the consequences of use of such information nor for any infringement of patents or other rights of third parties which may result from its use. No license is granted by implication or otherwise under any patent or patent rights of SGS-THOMSON Microelectronics. Specifications mentioned in this publication are subject to change without notice. This publication supersedes and replaces all information previously supplied. SGS-THOMSON Microelectronics products are not authorized for use as critical components in life support devices or systems without express written approval of SGS-THOMSON Microelectronics.

© 1994 SGS-THOMSON Microelectronics - All Rights Reserved

SGS-THOMSON Microelectronics GROUP OF COMPANIES
Australia - Brazil - France - Germany - Hong Kong - Italy - Japan - Korea - Malaysia - Malta - Morocco - The Netherlands -
Singapore - Spain - Sweden - Switzerland - Taiwan - Thailand - United Kingdom - U.S.A